

SuperHet - the Century old technology

FlexRadio - not your Dad's old radio

July 2025

Michael Walker VA3MW / KE2EAF
Marketing and Training



FlexRadio

Warning!

The goal today is to touch on a number of features and functions as we move forward into the non-SuperHet radio world. AKA Direct Sampling.

Hams are no longer tied to 1 desk, 1 computer, or 1 QTH.

And, more importantly, I have been known to entice attendees to spend more of their kids inheritance!



FlexRadio



© 2025 FlexRadio Systems — All Rights Reserved.

A





But, if you are a Knobs guy



Or, you just want to take it with you (Field Day)





A new day for the unexplored

Introducing the Aurora™ Series



FlexRadio continues to shake up the Ham Radio world!

- **FlexRadio shakes up the HF radio world over the last 22 years with advanced technology**
- **Better, faster, less expensive**
- **Quieter receivers**
- **Multiple receivers**
- **Built in SOR2, OTRSP, Bandpass filters**
- **Multiple Clients**
- **Multiple Users**
- **Simplest and most reliable Remote Operation**

May 2025 - FlexRadio does it again

- **Time to build the better transceiver with focus on the Transmitter**
- **Better, Faster, Less Expensive**
- **To go with DSP Receivers, we now have a DSP Transmitter**
- **500W output power**
- **100% Duty Cycle**
- **Uses less power than a microwave - 80-90% efficiency**
- **All the same features as 6000 and 8000 series**

Typical HF 500W station layout

Power Supply, Rig, Tuner, 500W amplifier



Aurora - The 500W all in one transceiver



Welcome to Aurora!

500W, Power Supply, Tuner - 160-6M



500W for 8 hours continuous
Radio temperature: ~80°F



Cool and Quiet!





Aurora - New HF Radio Disruptive Technology

- **Over 50dB IMD3 reduction (most radios are just over 30dB)**
- **No special ham shack wiring**
- **Amazing all in 1 radio for Remote Operation**
- **Amazingly portable - 17.7 pounds (POTA??)**
- **Small enough for carry on luggage**
- **Draws ~6 amps @ 120VAC ~80-90 efficient**
-



How?

In 1952, Leonard Kahn published a technical paper explaining how to make SSB transmissions by envelope elimination and restoration.

6 years ago, Tony K1KP and FlexRadio partnered to build the Aurora Series of radios.

Today, the Aurora series is becoming available

https://www.arrl.org/files/file/QEX_Next_Issue/Mar-Apr2017/MBF.pdf

aurora@flexradio.com for more information

The Polar Explorer

You may never look at your "linear amplifier" the same way again.

If you're like me, you have a love/hate relationship with your linear amplifier. While this year's "big loss" has worked out the legal limit the almost 20 years, it also presents some significant challenges. It seems to take forever to wrap up — especially when sitting down to work on all-time new steel because of the size and weight, it occupies its own piece of reinforced lumber in the shack. I have to keep it within easy reach because it doesn't save automatically. New tubes are not available, so the dwindling supply of matched pairs on the "new old stock" (NOS) market is driving up the price, even though they aren't guaranteed to last. Rather than simply spending several thousand dollars to replace the venerable sidekick of my SSB W transmitter, I decided to explore the feasibility of using a technique called polar modulation to reduce the size, weight and cost of a legal-limit base transmitter, hence the result, "The Explorer."

The Cost of RF Power

The high cost of high power is rooted in the evolution of base radio technology and equipment. Figure 1A shows the traditional modulation process of a high-power output stage operating at the carrier frequency with the modulation process at the high-power output stage. Figure 1B shows the single-sideband modulation process moved away from that high-power output stage back to an intermediate frequency (IF) operating at a very low power level. SSB signals presented at less than one watt at the IF are heterodyned to the carrier frequency and passed through three or more stages of amplification to reach levels useful for reliable communication over long distances with average antennas. Unlike CW and AM, SSB and other quadrature

amplitude modulated signals must undergo a relatively inefficient linear amplification to increase signal levels without distortion. To balance cost and performance, strictly nonlinear Class AB amplifiers are often used, requiring low-pass filters between stages to remove harmonic distortion products, and adding cost to the transmitter without adding value to the signal. Since the VFO and IF circuitry — including the repetitive electromechanical tuned filter — can be shared between the transmit and receive, manufacturers increasingly combined the formerly separate receiver and transmitter into a single "transceiver" to keep equipment prices within reach of a the vast population. But,

Efficiency and Amplifier Classes
Amplifiers traditionally employed in amateur RF amplifiers — Classes A, AB, B and C — operate the active device in its linear region for some part of the RF cycle. This means that there is voltage across the device while there is current flowing through the device, resulting in power dissipation in the device. By contrast, amplifiers in the earthquake Classes D, E, F and their variants (described in [1]) switch the active device between cutoff — zero current through the device — and saturation — zero voltage across the device. Switching amplifiers minimize power dissipated in the active device by minimizing the overlap of the periods of nonzero current and nonzero voltage, resulting in higher efficiency. The output networks of the switching amplifier classes are designed to optimize this behavior.

the marriage of convenience came at a price. Transistor improvements have been largely negated by massive improvements in advances in silicon technology integrated sponsored digital integrated circuits that supported analog circuits in a number of performance-critical roles. A "you as you go" power upgrade path was provided in what came to be known as a "linear amplifier" to augment the comparatively low output power of an affordable SSB transmitter because more efficient nonlinear amplifiers cannot be used to amplify SSB signals, about 80% more dc power needs to be provided to the "linear" amplifier to produce the same output power as a Class-C amplifier of a CW or AM transmitter.

As the convenience of no-tune solid-state amplifier technology displaced vacuum tube circuits, the single high-Q band-switched tank circuit gave way to a switched bank of five or six low-pass filters (tuned to various excursions). Each filter section requires several custom-wound inductors and ceramic capacitors that can sustain high RF currents, once again adding cost without adding value to the signal. In today's era of concern over energy efficiency, it's one of the least of the fact that a significant fraction of the total cost of an RF-power amplifier is driven by the need to generate nearly twice as much dc power as the RF power that will be sent up the transmission line, and the need to dissipate the difference. This inefficiency also requires RF transformers to be made with exotic insulating materials that can survive high energy densities, plus high-conductivity heat sinks and fans to remove the heat produced by the dissipated power.

Superhetrodyne VS. Direct Sampling Radio

Cleaner Signal Path: Direct sampling digitizes the RF signal immediately, eliminating multiple analog mixing stages that can introduce distortion and noise found in superhet designs.

Superior Dynamic Range: By converting signals directly to digital, direct sampling receivers achieve higher dynamic range, better handling strong signals near weak ones without overload or interference.

Reduced Spurious Responses: Direct sampling minimizes image frequencies and spurious signals common in superhet receivers because it doesn't rely on multiple frequency conversions.

Simplified Architecture: Fewer analog components mean greater reliability, less maintenance, and lower chances of component drift affecting performance over time.

Advanced Digital Processing: Direct sampling enables powerful DSP techniques (noise reduction, filtering, adaptive notch) to be applied earlier and more precisely, improving overall reception quality.



Analog Drawbacks

- **Demodulation and Modulation require separate circuits for every mode of operation**
- **New modulations cannot be added after design**
- **Bandwidth of output typically restricted**
- **Multiple heterodyne stages result in distortion**
- **Phase noise**
- **Image rejection**
- **Selectivity**
- **Unable to scale**

FlexRadio – Direct Sampling

- **Wide Frequency Coverage** - Direct sampling allows SDRs to cover a wide range of frequencies without the need for traditional, dedicated hardware filters
- **Reduced Complexity:** By eliminating many analog components, such as mixers and filters, direct sampling simplifies the radio's hardware design. This can result in more compact and cost-effective SDRs.
- **Improved Signal Purity:** Direct sampling can lead to better signal purity and lower phase noise since there are fewer analog components that can introduce distortion or noise into the signal path.
- **Flexibility for New Modes and Features:** With direct sampling, new modes and features can often be added to the SDR through software updates, expanding the radio's capabilities and compatibility with emerging standards.
- **Higher Dynamic Range:** SDRs with direct sampling often have a higher dynamic range compared to traditional superhet receivers. This means they can handle both weak and strong signals simultaneously without distortion, making them less prone to overload and intermodulation distortion.
- **Quieter:** - You will hear the difference immediately when you put the headphones on. The radio is just quieter.

What is an SDR? (not this)

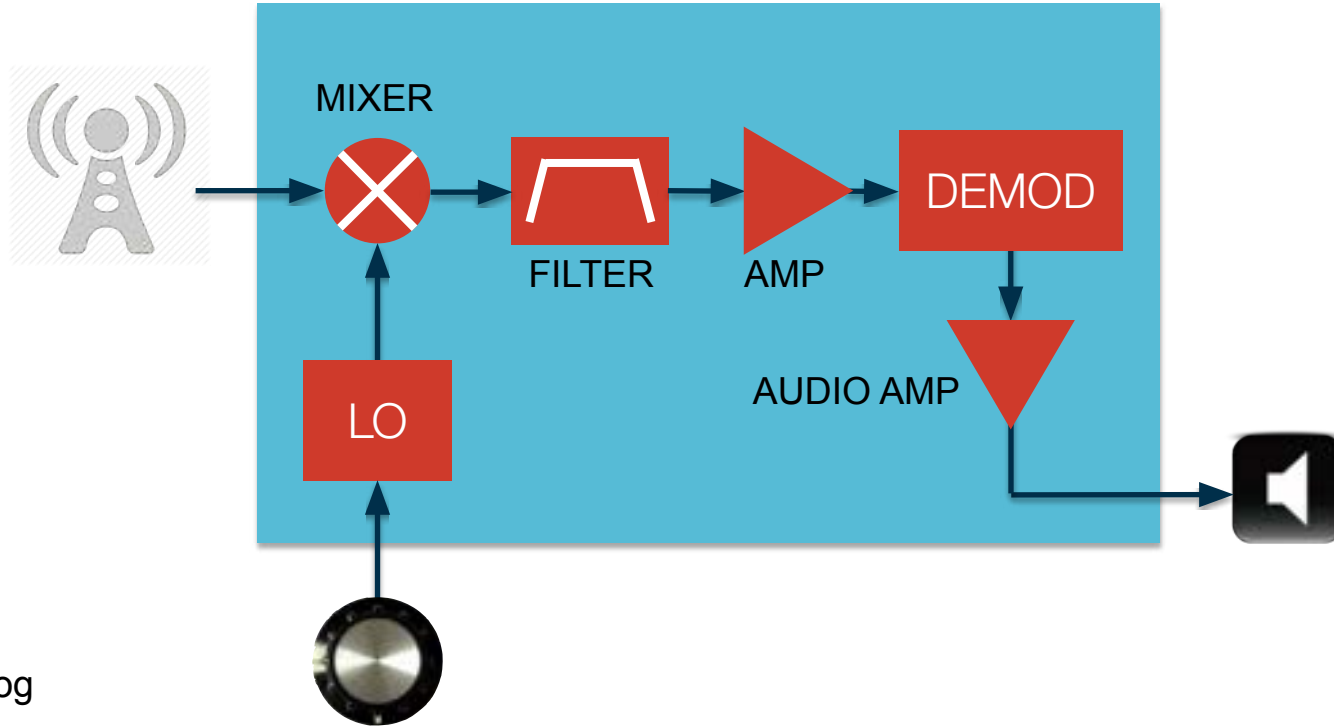

 Analog
 Digital

Some would call this an SDR... (no, it is a hybrid)

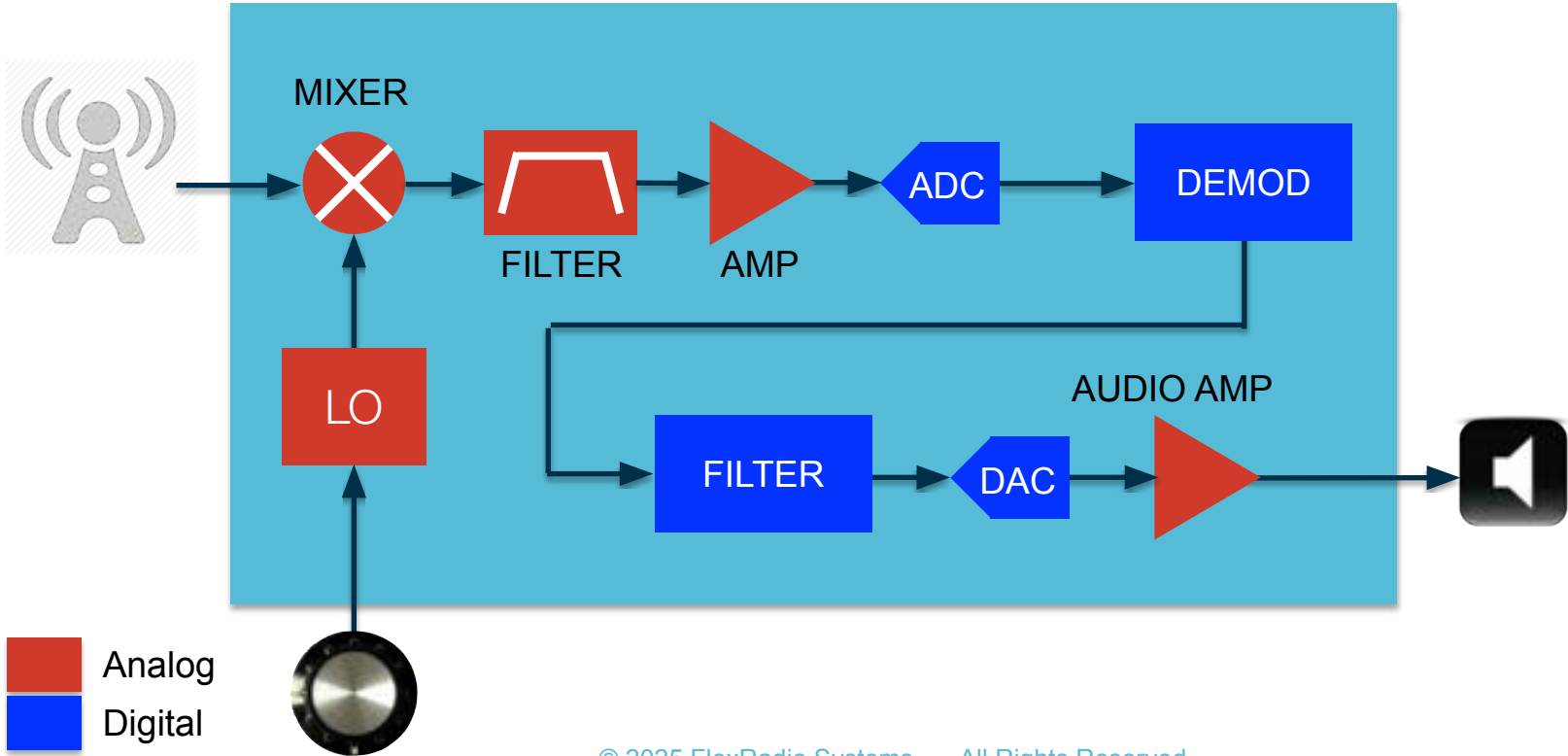

Direct Sampling SDR

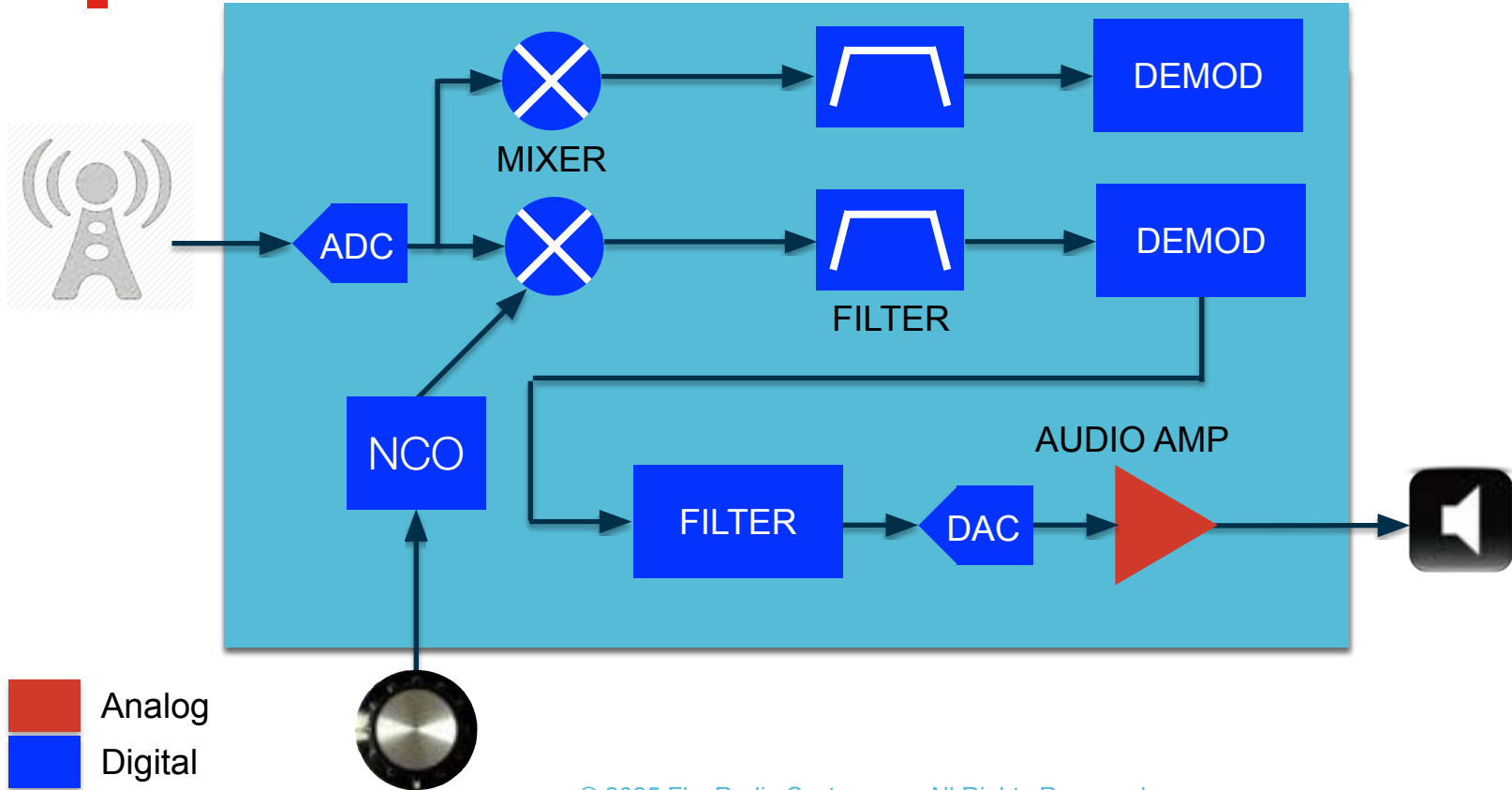

What is an SCU - Spectral Capture Unit?



- The SCU, or Spectral Capture Unit, is a fundamental component of FlexRadio's software-defined radios.
- It serves as the interface between the analog RF signals from the antenna and the digital processing performed by the SDR software in the FPGA - Field Programmable Gate Array.
- SCUs are designed to sample and digitize a wide range of RF frequencies and bandwidths, enabling the flexibility and adaptability that characterize software-defined radios.
- FLEX-6300, FLEX-6400/8600(M) and FLEX-6500 have 1 SCU that sample from 30Khz to 54Mhz 100% of the time at a 16bit sampling rate
- FLEX-6600/8800(M) has 2 SCU's that sample from 2 different antenna systems from 30Khz to 54Mhz 100% of the time
- FLEX-6700 has 2 SCU's that sample from 2 different antenna system from 30 kHz-60 MHz and 135-165 MHz
- The SCU plays a crucial role in delivering the high-performance capabilities and versatility that make FlexRadio devices popular among amateur radio operators and professionals alike.

1 or 2 SCU's?

**FLEX-6300,6400(M),8400(M),6500
have 1 SCU**

- Ideal for small antenna systems with multiband antennas (eg: HF6V vertical)
- Only 1 antenna port active at a time
- You can have different RX and TX antennas
- 1 RX and Transverter ports (6300 only has a Transverter port)



1 or 2 SCU's?

FLEX-6700, 6600(M), 8600M- 2 SCU's

- Mix and Match Antennas with Slices
- 2 Transverter ports and 2 RX ports
- Diversity reception
- Full Duplex Satellite operation

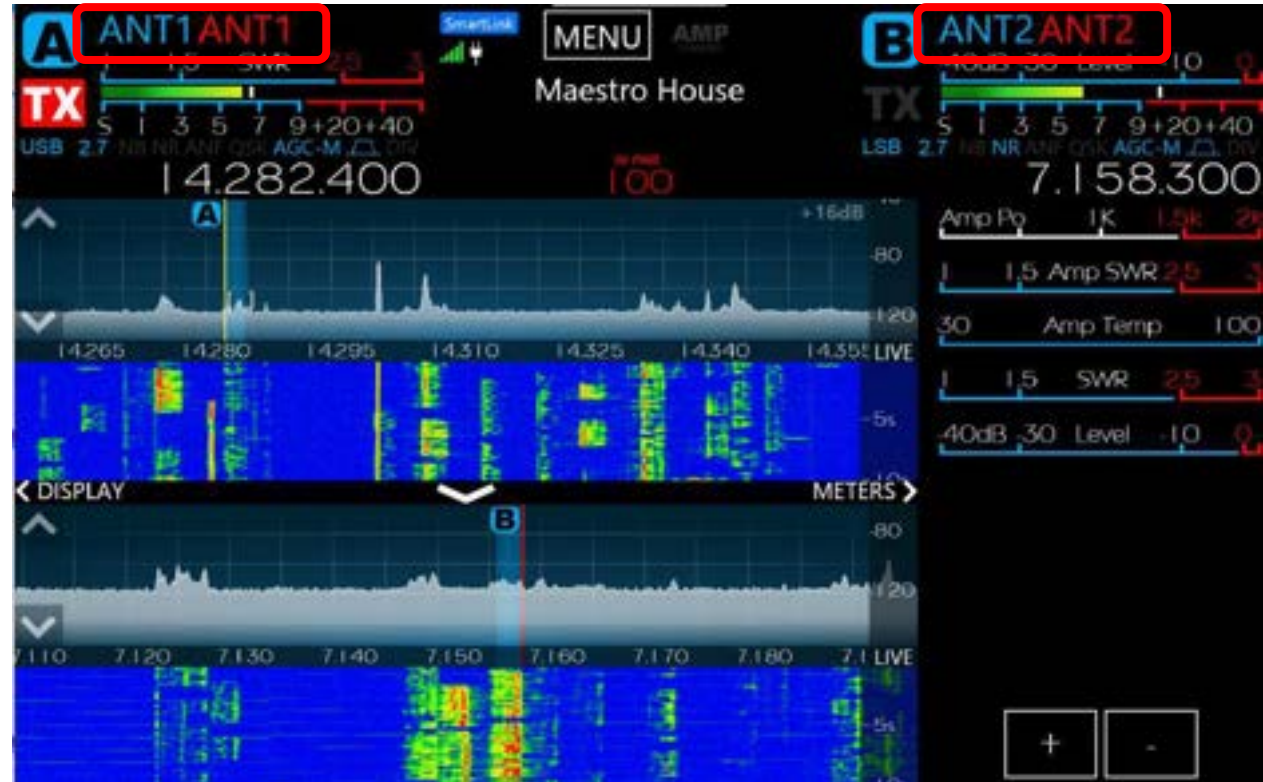
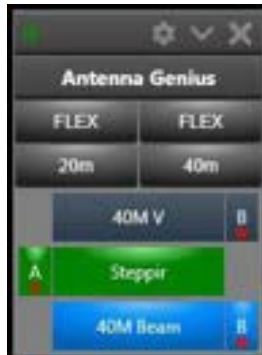

Radio Clients

A client is the user interface, also known as the GUI (Graphical User Interface).

- [SmartSDR for Windows](#)
- **Maestro** - stand alone control head
- 6400M/8400M/Aurora or 6600M/8400M/Aurora front panel - stand alone
- [SmartSDR for iOS](#) - paid
- [SmartSDR for MAC](#) - paid
- [DogParkSDR for MAC](#) - paid



SmartSDR Windows Client



- SmartSDR is the basic FlexRadio client
- It runs on Windows
 - Windows 10 or 11 Pro preferred but not required
- It works with all 6000 series radios
- Most computers purchased in the last 3 years are more than powerful enough
- Use of digital mode decoding programs (FT8, PSK31, SSTV, RTTY, etc) may require a more powerful computer

Receiver Slice

FlexRadio 6000 series support 2, 4 or 8 slices depending on the model

A Slice has the ability to receive anywhere from a spectrum of 30 khz to 54 Mhz (6700 adds 2M coverage).

Additional slices have access to the same spectrum at the same time.

All spectrum, waterfall and slice processing occurs on the radio.

You are not limited to additional slices being on the same band



Wide Noise Blanker

Power line noise

Listen



FlexRadio 6000/8000 Series



All FLEX-x400, x600, 6700 & Aurora models:

- Contest grade receivers
- SmartLink included (remote operation)
- Version 3 software included (free)
- All client types can connect
- MultiFlex included
- Controlled Envelope SSB included (CESSB)
- Band Pass Filters included
- Unlimited external automated device control for Amplifiers, Filters, etc

Hardware Overview Video:

<https://youtu.be/Nn-GEhL5u2c>

FLEX-8000 + Aurora Features

Feature	Benefit
Built on the successful FLEX-64/6600 base architecture and chassis	Customer familiarity
Enhanced performance (~4x CPU; ~2x FPGA)	Opens door to many new applications and capabilities (roadmap discussion)
Enhanced M-Series performance based on successful Maestro-C (~2x display performance)	Opens door to many new applications and capabilities
Integrated GNSS receiver with external Antenna included	Radio always on frequency
Optional, more capable GPSDO with 10MHz output; higher performance	10MHz can feed other shack equipment; suitable for more demanding environments

	X400 AU-510	x400M AU-510M	X600 AU-520	x600M AU-520M
SCUs	1	1	2	2
ATU	Optional AU-520 incl.	Optional AU-510M incl.	included	included
Front Panel Display	no	yes	no	yes
Slices	2	2	4	4
Transverter	1	1	2	2
RX Antennas	1	1	2	2
Bandpass Filters	30db	30db	55db	55db
GNSS + ADP	8400 + Aurora	8400M + Aurora	8600 + Aurora	8600M + Aurora

Controlled Envelope SSB

Controlled Envelope SSB greatly increases your SSB “talk power” by accurately limiting envelope peaks in the SSB modulator. Generate SSB without the big overshoot peaks that make ALC necessary with conventional SSB modulators.

Watch your wattmeter read higher than before.

An increase is ~2.8db RF power in SSB mode

http://www.arrl.org/files/file/QEX_Next_Issue/2014/Nov-Dec_2014/Hershberger_QEX_11_14.pdf

http://www.arrl.org/files/file/QEX_Next_Issue/2016/January_February_2016/Hershberger_QEX_1_16.pdf

<https://youtu.be/nAGUmHrO3Ac>

Conventional SSB (blue) and CESSB (red) RF waveforms
PEP is the same for both!

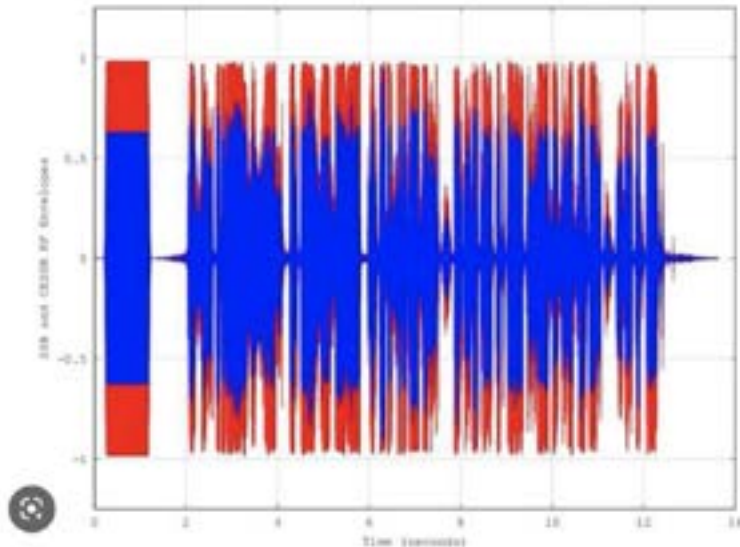

SO2R Made Easy

PGXL - Linear Amplifier



Power Genius XL - Legal Limit LDMOS

- Dual Exciter Support
- FlexRadio and OEM Radio configurations
- Harmonic dummy load
- Complete band isolation
- MeFFa - Maximum Efficiency Algorithm
- 2000 watts output power

FlexRadio Tuner Genius XL

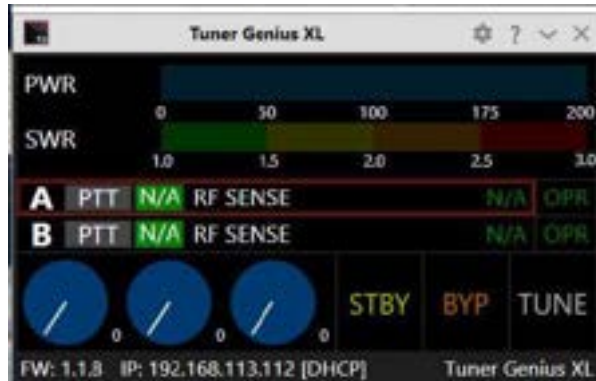

- 1.8Mhz to 54Mhz coverage
- Legal Limit output - up to 2000 watts
- Integrates with any transceiver (RS232, CI-V, Pin to Band)
- SO2R or 1x3 output
- Low drive, Frequency Out of Range, Wrong band, and High power warning alarms
- Designed to complement FLEX-6000/8000 series transceivers and the Power Genius XL™ amplifier
- Seamless SmartSDR™ software integration
- Complete control and monitoring (over LAN) from an intuitive Windows™ application
- Contest ready - the ONLY single-radio SO2R solution in amateur radio
- Fast tuning (2-12 sec) with memories (20ms)
- High accuracy SWR and power meter measures in bypass mode.... and much more.
- Works with all types of HF Radio - Flex and OEM
- 100% ICAS Duty Cycle

There is no other tuner on the market like this one!





SmartSDR, Power Genius XL, Tuner Genius XL & Antenna Genius demo



OEM HF Radio Power Genius XL + Tuner Genius XL Integration



Maximum Flexibility – Diversity Reception

How all the hardware talks to each other

Your Shack network should be a Star design with all devices connected to your network switch or router.

- Radio connected to Switch
- Computer connected to Switch
- WiFi connected to switch
- Internet connected to switch

This allows for all devices to communicate with each other.

Pretty simple, eh?

<https://helpdesk.flexradio.com/hc/en-us/articles/202118558-How-to-Connect-your-FLEX-6000-to-a-LAN>

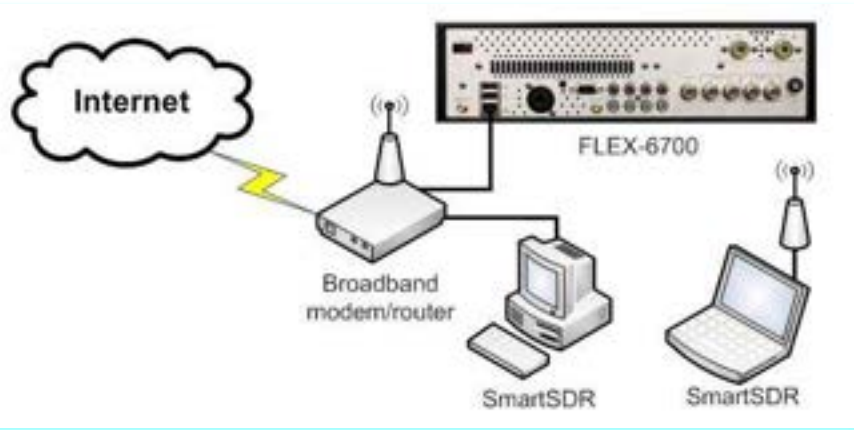

Digital Operation

No extra hardware required



SmartSDR CAT and DAX replace hardware devices

- Interface direct WSJTx, DM780, FLDigi and more
- SliceMaster helps with interfacing and decomplicates things

<https://github.com/K1DBO/slice-master-6000>

Video:

<https://youtu.be/ww8CcGNAzg>

Share the Radio load

- Ham Shack Lan connectivity
- Share functions amount multiple devices
- Log on 1 computer
- Digital on a different computer



User Interface via

- Maestro
- PC audio via any PC, MAC or iPhone, iPad
- Actual Radio

Mix and match

Sorry, the
static crash
wiped you
out.

Very fast
AGC!

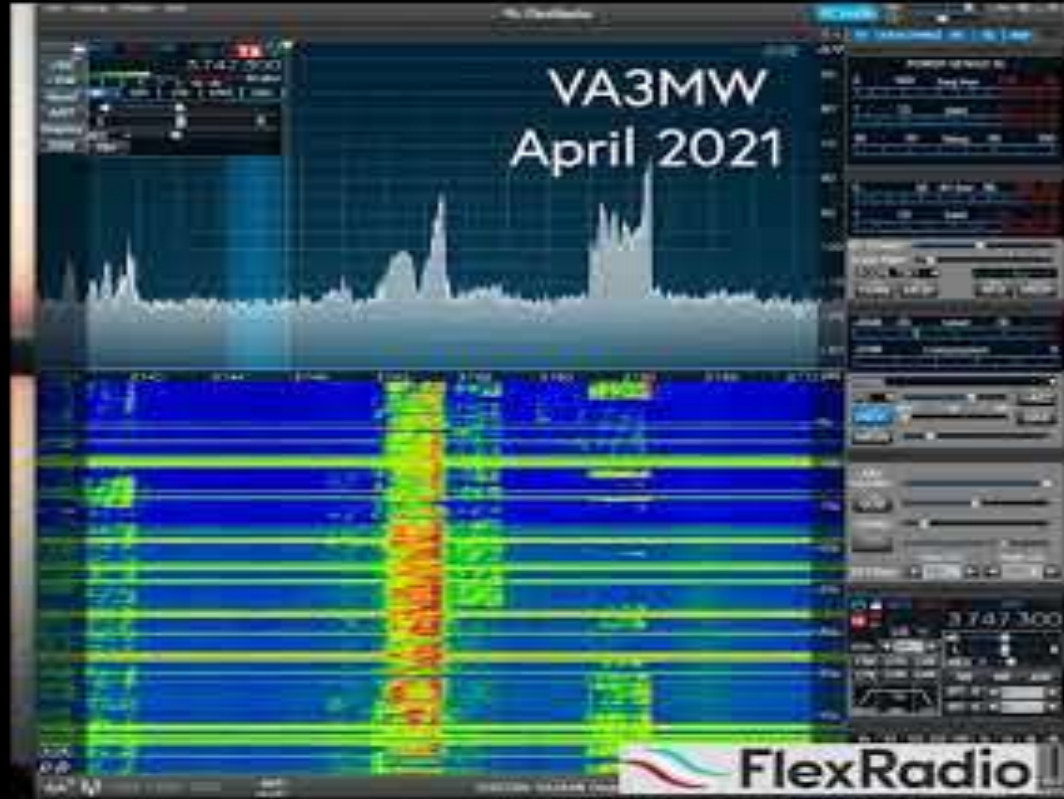

FlexRadio MultiFlex

- MultiFlex allows 2 clients to use the same radio at the same time.
- The clients can be in your home shack network
- Or, 1 can be remote using SmartLink
- Clients can be a mix of client types.
- Part of SmartSDR 3.x



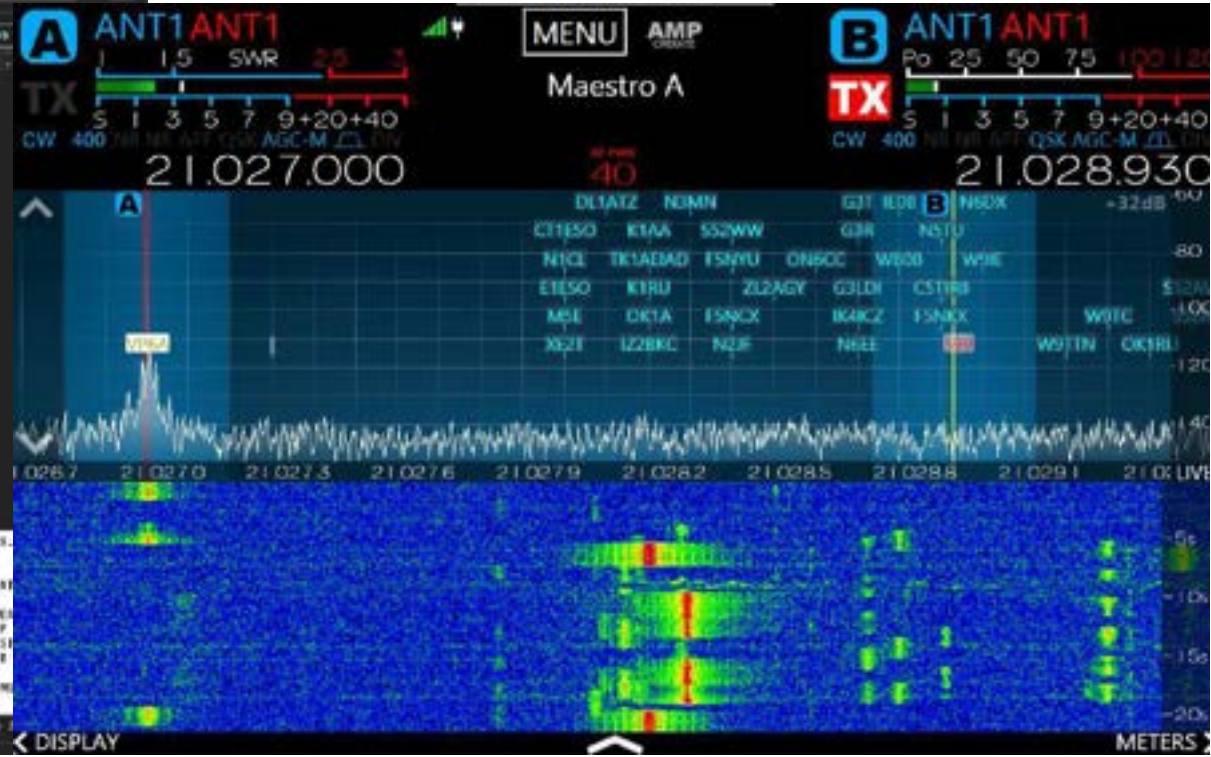
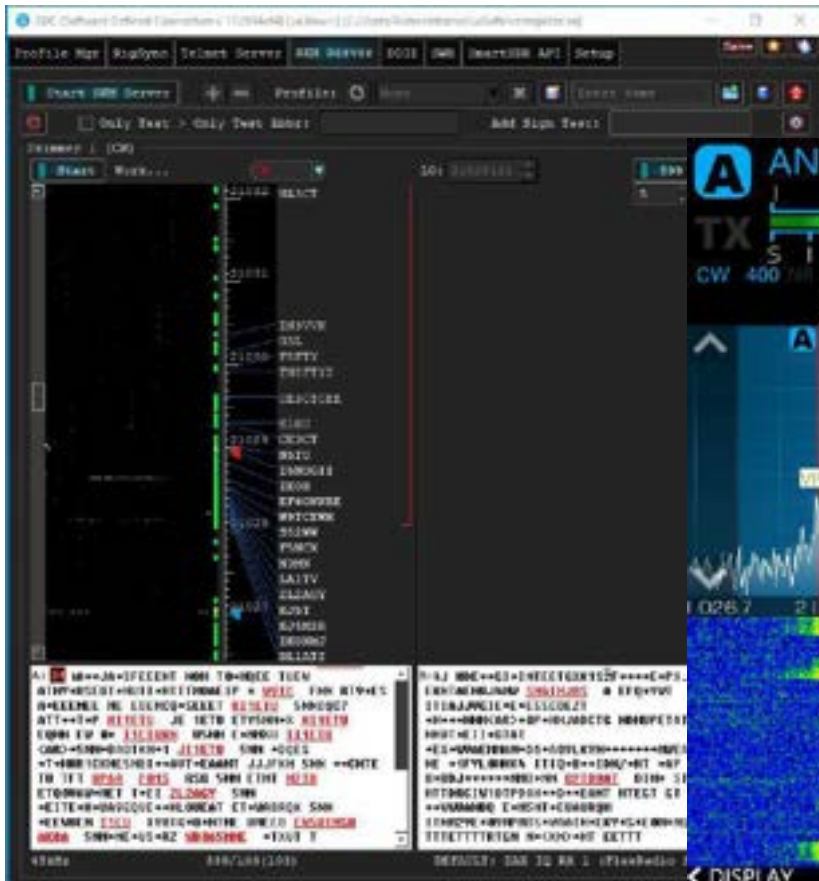

SDC CW Skimmer - decodes the radio IQ Stream <https://www.lw-sdc.com/>

Working a
DXPedition

The easy
way!

8Q7DX from
Toronto

13,965 km
away



HF Remote Operation



SmartLink Connection

Old School VPN Requires:

- Client computers
- Server computers
- Specialized network configuration
- Reserved IP addresses
- Router Port Forwarding configurations
- Static IP or IP following (DynDNS, etc)
- Network experience

SmartLink - VPN not required:

- No specialized configuration required
- Plug and play - uPNP router required
- Provides TLS Encryption security
- Operator security
- Seamless
- PC, MAC or iOS device connectivity
- Peer to Peer connection
- Included with each radio - Free

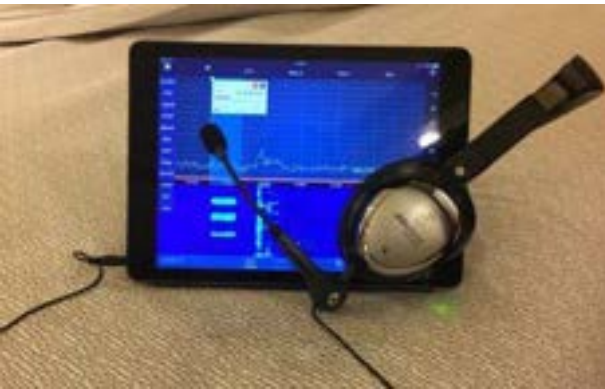

What can I do with an HF SDR 100 W radio? Aka: FlexRadio



- HF DX contacts in all modes at 100 watts 160~6M
- Contesting
- Rag Chew
- Be an Elmer
- Build an SO2R station
- Use just about any digital mode/software (WSJTx, FLDigi, HRD, N3FJP, SatPC32, etc)
- Be an SWL
- Use your Radio remotely - put your radio in a quiet location
- Work satellites by adding transverters
- Weak signal, microwave IF Radio
- Write your own user interface
- And, they aren't expensive

And, so much more

HF Radio Game Changers

GAME CHANGER

- Brick wall filtering from 50hz to 10khz (both RX and TX)
- Multiple main receivers
- Wide Noise Blanker
- Amazing AGC Performance
- CESSB for 2.8db more RF out in SSB
 - Free Power!
- Amazing digital performance - FT8, RTTY etc.
- Built in Band Pass filters for S02R or Field Day events

HF Radio Game Changers

GAME CHANGER

- No extra audio cables required
- Multi-Flex - dual clients at the same time
- SO2R features built in including OTRSP
- Complete station integration
- Remote operating included - no network skills required
- Complete HF station integration - PGXL, TGXL + more
- Many add on programs that interface directly with the radio
- FlexRadio API for programmers
 - Node-Red and more

HF Radio Game Changers Aurora

Now 500 watts in 1 compact design

- PS, Rig, Tuner and Amplifier all in one
- Super efficient
- Uses less power than your toaster at full 500 watt power
- Quiet
- Cool
- SO2R ready (AU-520(M))
- Portable
- Remoteable

GAME CHANGER

FlexRadio Social Media Online



- We are active on Facebook - FlexRadio Enthusiasts - over 10,000 members
- FlexRadio Community
<https://community.flexradio.com>
- HelpDesk - including white papers and how do
<https://helpdesk.flexradio.com>
- YouTube - FlexRadio channel (over 50 help videos)
<https://www.youtube.com/user/FlexRadioSystems/videos>
- Direct email - hams@flexradio.com or info@flexradio.com
- Direct number: 1-512-535-4713
- 2 Year warranty - upgradable to 4 years
- 30 day return policy - take it for a test drive
- **We take trade ins!**
 - <https://www.flexradio.com/trade-in/>



FlexRadio

Michael Walker
Info
Sales

michael@flexradio.com
info@flexradio.com
sales@flexradio.com

www.flexradio.com



FlexRadio



FlexRadio



FlexRadio



FlexRadio